



RF Power Field Effect Transistors

N-Channel Enhancement-Mode Lateral MOSFETs

Designed for W-CDMA base station applications at frequencies from 2110 to 2170 MHz. Suitable for TDMA, CDMA and multicarrier amplifier applications. To be used in Class AB for PCN - PCS/cellular radio and WLL applications.

- Typical 2-Carrier W-CDMA Performance: $V_{DD} = 28$ Volts, $I_{DQ} = 1200$ mA, $P_{out} = 28$ Watts Avg., Full Frequency Band, Channel Bandwidth = 3.84 MHz, PAR = 8.5 dB @ 0.01% Probability on CCDF.
 Power Gain — 13.5 dB
 Efficiency — 26%
 IM3 @ 10 MHz Offset — -37 dBc in 3.84 MHz Channel Bandwidth
 ACPR @ 5 MHz Offset — -39 dBc in 3.84 MHz Channel Bandwidth
- Capable of Handling 10:1 VSWR, @ 28 Vdc, 2140 MHz, 92 Watts CW Output Power

Features

- Characterized with Series Equivalent Large-Signal Impedance Parameters
- Internally Matched for Ease of Use
- Qualified Up to a Maximum of 32 V_{DD} Operation
- Integrated ESD Protection
- Lower Thermal Resistance Package
- Low Gold Plating Thickness on Leads, 40 μ " Nominal.
- RoHS Compliant
- In Tape and Reel. R3 Suffix = 250 Units per 56 mm, 13 inch Reel.

MRF5S21130HR3
MRF5S21130HSR3

2110-2170 MHz, 28 W AVG., 28 V
2 x W-CDMA
LATERAL N-CHANNEL
RF POWER MOSFETs

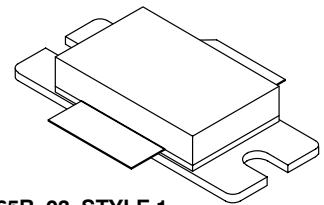

CASE 465B-03, STYLE 1
NI-880
MRF5S21130HR3

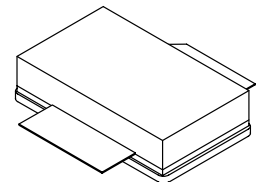

CASE 465C-02, STYLE 1
NI-880S
MRF5S21130HSR3

Table 1. Maximum Ratings

Rating	Symbol	Value	Unit
Drain-Source Voltage	V_{DSS}	-0.5, +65	Vdc
Gate-Source Voltage	V_{GS}	-0.5, +15	Vdc
Total Device Dissipation @ $T_C = 25^\circ\text{C}$ Derate above 25°C	P_D	372 2.13	W W/ $^\circ\text{C}$
Storage Temperature Range	T_{stg}	- 65 to +150	$^\circ\text{C}$
Case Operating Temperature	T_C	150	$^\circ\text{C}$
Operating Junction Temperature	T_J	200	$^\circ\text{C}$
CW Operation @ $T_C = 25^\circ\text{C}$ Derate above 25°C	CW	100 0.54	W W/ $^\circ\text{C}$

Table 2. Thermal Characteristics

Characteristic	Symbol	Value (1,2)	Unit
Thermal Resistance, Junction to Case Case Temperature 80°C , 92 W CW Case Temperature 76°C , 28 W CW	$R_{\theta JC}$	0.44 0.47	$^\circ\text{C}/\text{W}$

1. MTTF calculator available at <http://www.freescale.com/rf>. Select Tools/Software/Application Software/Calculators to access the MTTF calculators by product.
2. Refer to AN1955, *Thermal Measurement Methodology of RF Power Amplifiers*. Go to <http://www.freescale.com/rf>. Select Documentation/Application Notes - AN1955.

Table 3. ESD Protection Characteristics

Test Conditions	Class
Human Body Model	2 (Minimum)
Machine Model	M4 (Minimum)
Charge Device Model	C7 (Minimum)

Table 4. Electrical Characteristics ($T_C = 25^\circ\text{C}$ unless otherwise noted)

Characteristic	Symbol	Min	Typ	Max	Unit
----------------	--------	-----	-----	-----	------

Off Characteristics

Zero Gate Voltage Drain Leakage Current ($V_{DS} = 65\text{ Vdc}$, $V_{GS} = 0\text{ Vdc}$)	I_{DSS}	—	—	10	μAdc
Zero Gate Voltage Drain Leakage Current ($V_{DS} = 28\text{ Vdc}$, $V_{GS} = 0\text{ Vdc}$)	I_{DSS}	—	—	1	μAdc
Gate-Source Leakage Current ($V_{GS} = 5\text{ Vdc}$, $V_{DS} = 0\text{ Vdc}$)	I_{GSS}	—	—	1	μAdc

On Characteristics

Gate Threshold Voltage ($V_{DS} = 10\text{ Vdc}$, $I_D = 300\ \mu\text{Adc}$)	$V_{GS(th)}$	2.5	2.7	3.5	Vdc
Gate Quiescent Voltage ($V_{DS} = 28\text{ Vdc}$, $I_D = 1200\text{ mAdc}$)	$V_{GS(Q)}$	—	3.7	—	Vdc
Drain-Source On-Voltage ($V_{GS} = 10\text{ Vdc}$, $I_D = 3\text{ Adc}$)	$V_{DS(on)}$	—	0.26	0.3	Vdc
Forward Transconductance ($V_{DS} = 10\text{ Vdc}$, $I_D = 3\text{ Adc}$)	g_{fs}	—	7.5	—	S

Dynamic Characteristics ⁽¹⁾

Reverse Transfer Capacitance ($V_{DS} = 28\text{ Vdc} \pm 30\text{ mV(rms)ac}$ @ 1 MHz, $V_{GS} = 0\text{ Vdc}$)	C_{rss}	—	2.6	—	pF
-----------------------------------------------------------------------------------------------------------------------	-----------	---	-----	---	----

Functional Tests (In Freescale Test Fixture, 50 ohm system) $V_{DD} = 28\text{ Vdc}$, $I_{DQ} = 1200\text{ mA}$, $P_{out} = 28\text{ W Avg.}$, $f_1 = 2112.5\text{ MHz}$, $f_2 = 2122.5\text{ MHz}$ and $f_1 = 2157.5\text{ MHz}$, $f_2 = 2167.5\text{ MHz}$, 2-carrier W-CDMA, 3.84 MHz Channel Bandwidth Carriers, ACPR measured in 3.84 MHz Channel Bandwidth @ $\pm 5\text{ MHz}$ Offset. IM3 measured in 3.84 MHz Channel Bandwidth @ $\pm 10\text{ MHz}$ Offset. PAR = 8.5 dB @ 0.01% Probability on CCDF.

Power Gain	G_{ps}	12	13.5	—	dB
Drain Efficiency	η_D	24	26	—	%
Intermodulation Distortion	IM3	—	-37	-35	dBc
Adjacent Channel Power Ratio	ACPR	—	-39	-37	dBc
Input Return Loss	IRL	—	-12	-9	dB

1. Part internally matched both on input and output.

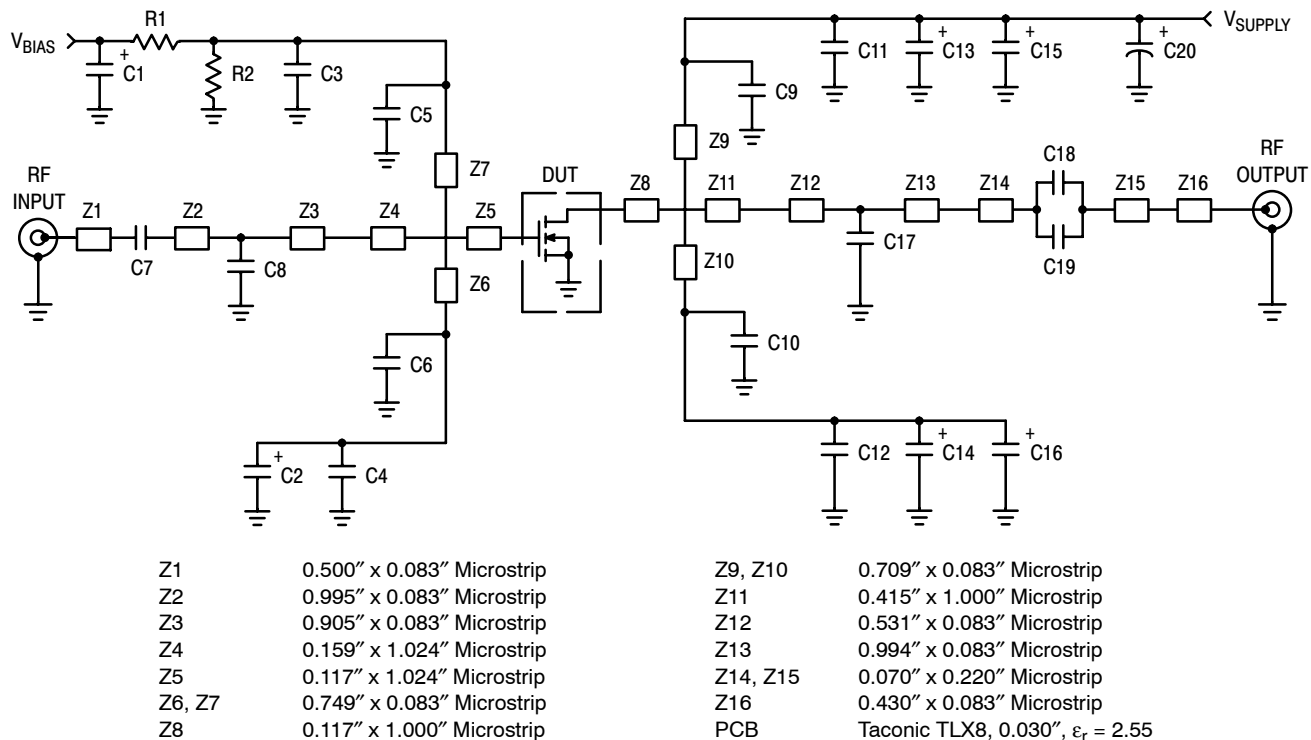
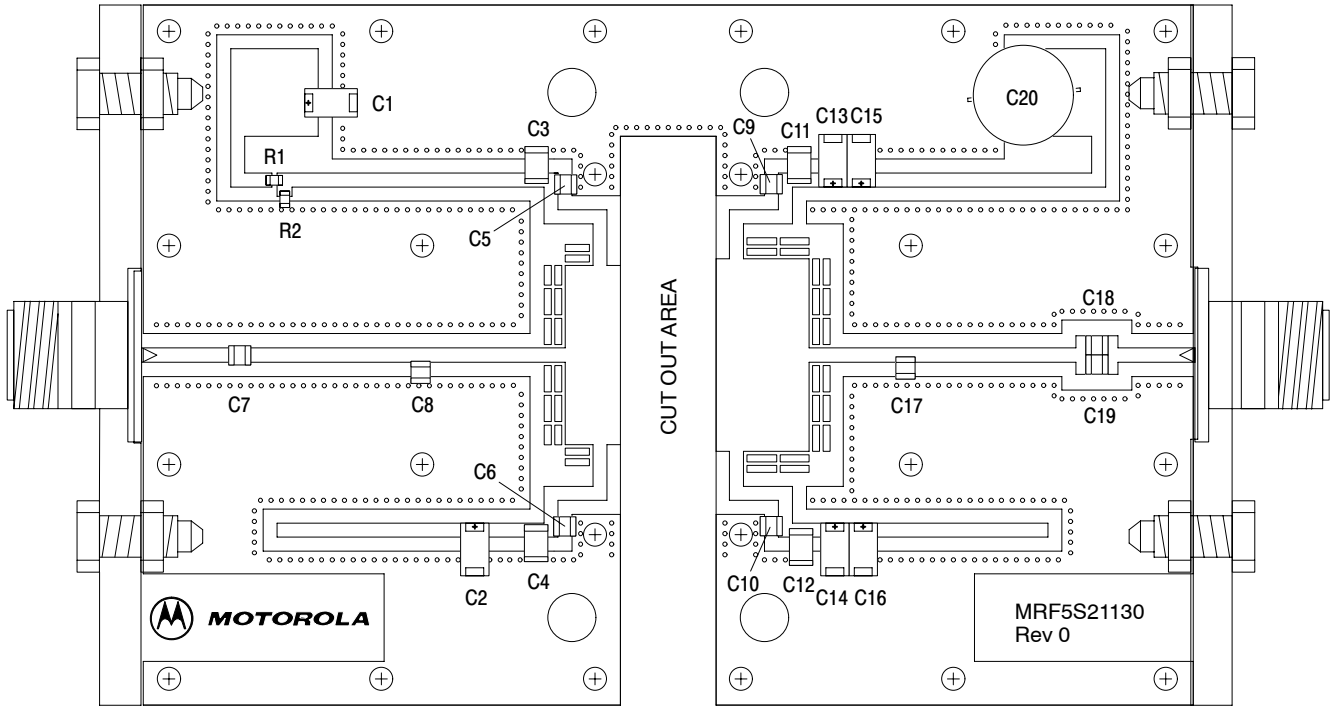

Figure 1. MRF5S21130HR3(SR3) Test Circuit Schematic

Table 5. MRF5S21130HR3(SR3) Test Circuit Component Designations and Values

Part	Description	Part Number	Manufacturer
C1, C2, C13, C14, C15, C16	10 μ F, 35 V Tantalum Capacitors	293D1106X9035D	Vishay - Sprague
C3, C4, C11, C12	220 nF Chip Capacitors (1812)	1812Y224KXA	Vishay - Vitramon
C5, C6, C7, C9, C10, C18, C19	6.8 pF 100B Chip Capacitors	100B6R8CW	ATC
C8	0.1 pF 100B Chip Capacitor	100B0R1BW	ATC
C17	0.5 pF 100B Chip Capacitor	100B0R5BW	ATC
C20	220 μ F, 63 V Electrolytic Capacitor, Radial	13668221	Philips
R1, R2	1 k Ω , 1/4 W Chip Resistors		



Freescall has begun the transition of marking Printed Circuit Boards (PCBs) with the Freescall Semiconductor signature/logo. PCBs may have either Motorola or Freescall markings during the transition period. These changes will have no impact on form, fit or function of the current product.

Figure 2. MRF5S21130HR3(SR3) Test Circuit Component Layout

TYPICAL CHARACTERISTICS

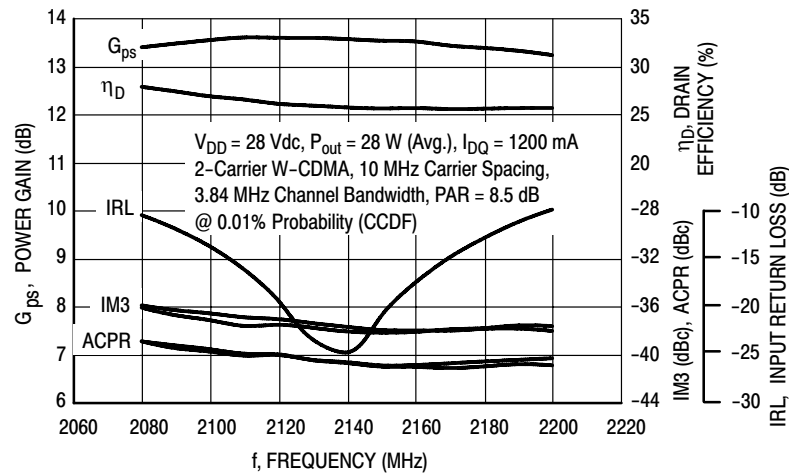

Figure 3. 2-Carrier W-CDMA Broadband Performance @ $P_{out} = 28$ Watts Avg.

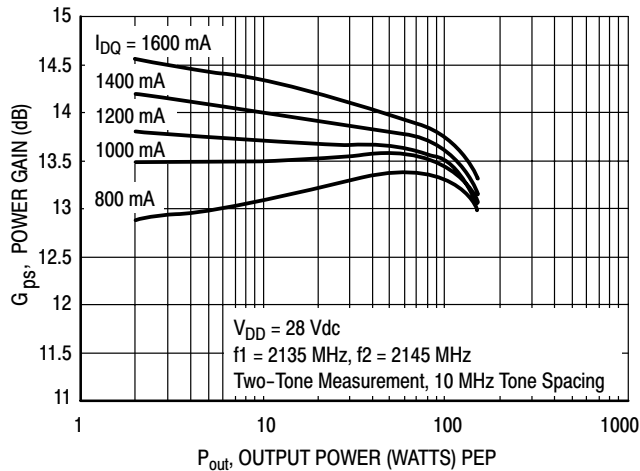

Figure 4. Two-Tone Power Gain versus Output Power

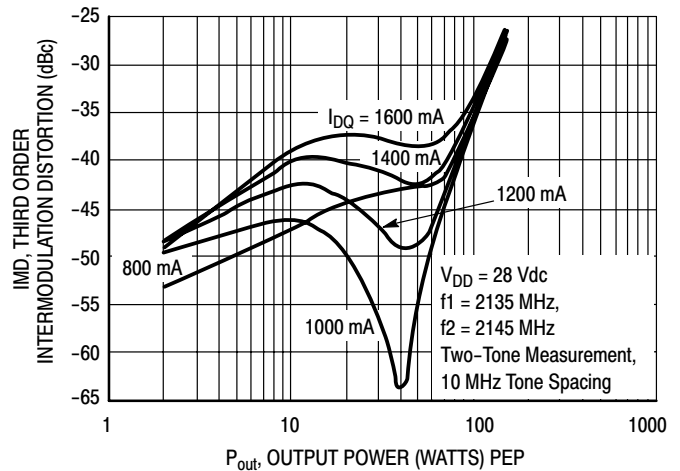

Figure 5. Third Order Intermodulation Distortion versus Output Power

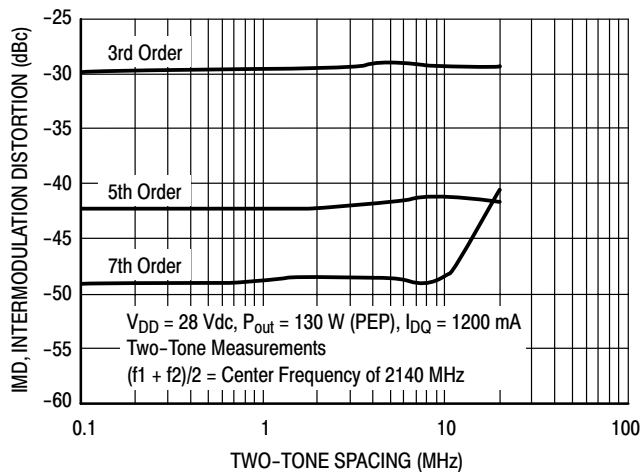

Figure 6. Intermodulation Distortion Products versus Tone Spacing

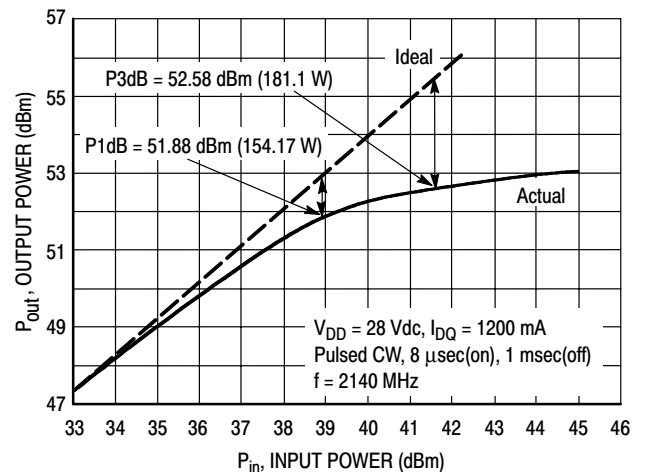

Figure 7. Pulse CW Output Power versus Input Power

TYPICAL CHARACTERISTICS

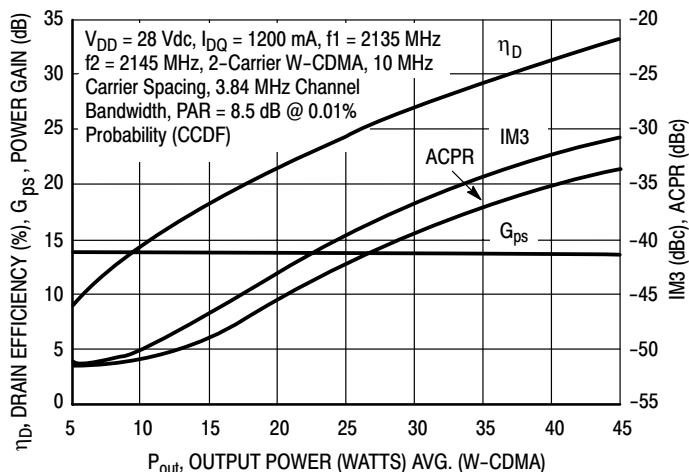
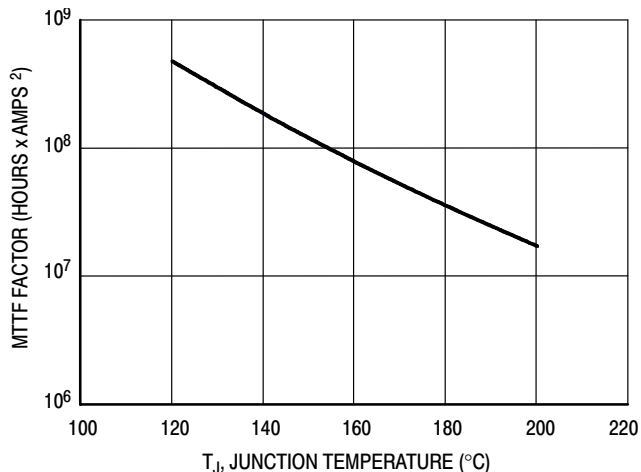

Figure 8. 2-Carrier W-CDMA ACPR, IM3, Power Gain and Drain Efficiency versus Output Power



This above graph displays calculated MTTF in hours x amperes² drain current. Life tests at elevated temperatures have correlated to better than $\pm 10\%$ of the theoretical prediction for metal failure. Divide MTTF factor by I_D^2 for MTTF in a particular application.

Figure 9. MTTF Factor versus Junction Temperature

W-CDMA TEST SIGNAL

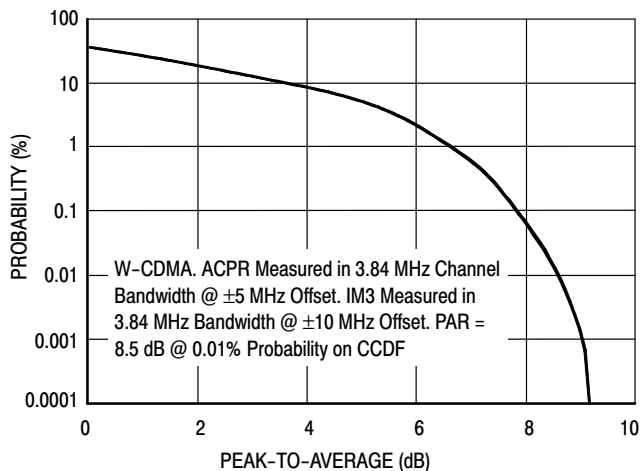

Figure 10. CCDF W-CDMA 3GPP, Test Model 1, 64 DPCH, 67% Clipping, Single-Carrier Test Signal

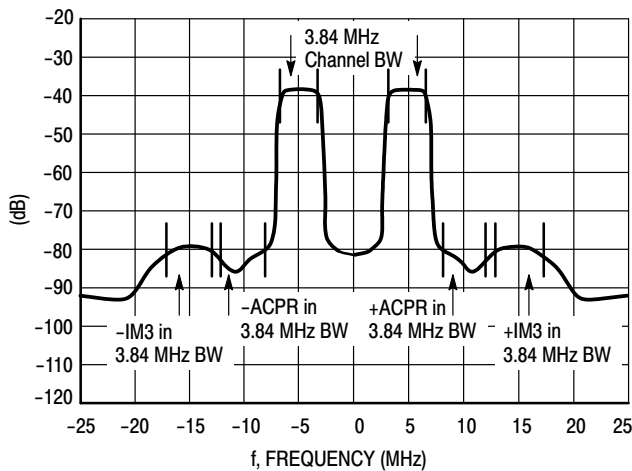
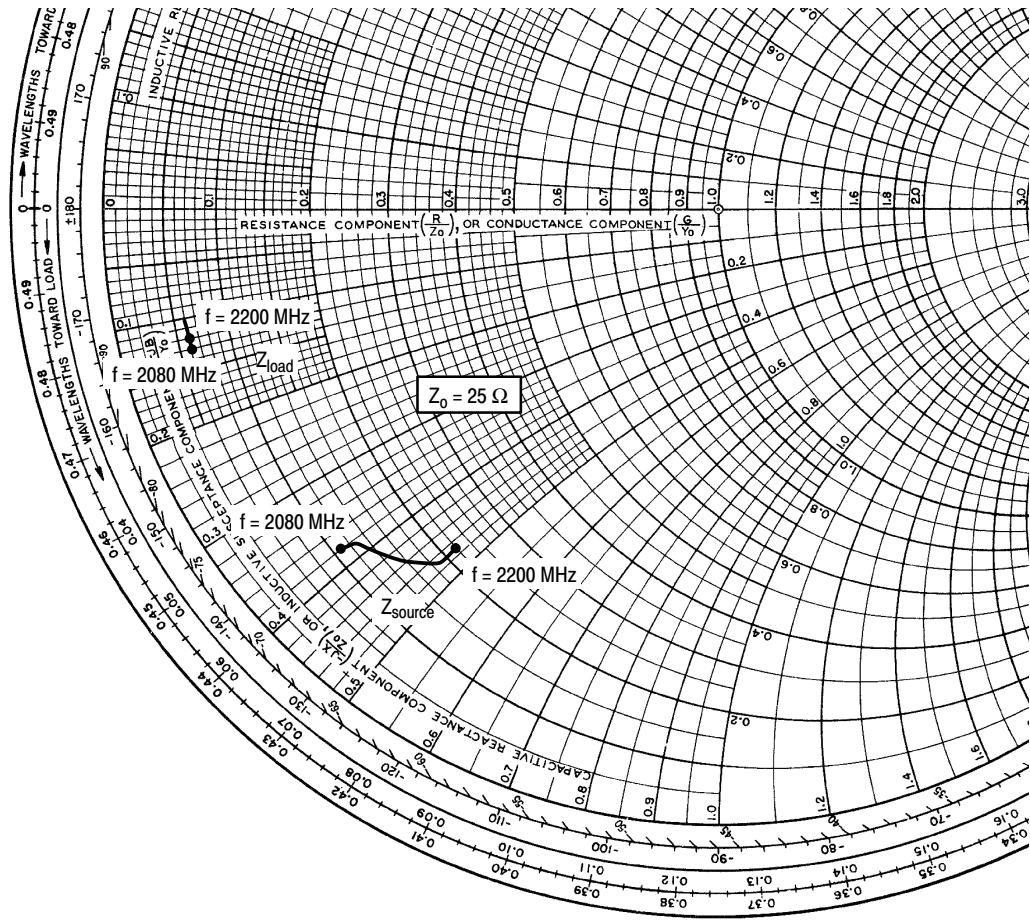

Figure 11. 2-Carrier W-CDMA Spectrum



$V_{DD} = 28 \text{ Vdc}$, $I_{DQ} = 1200 \text{ mA}$, $P_{out} = 28 \text{ W Avg.}$

f MHz	Z_{source} Ω	Z_{load} Ω
2080	$2.87 - j9.49$	$1.51 - j2.97$
2110	$3.13 - j9.86$	$1.52 - j2.54$
2140	$4.05 - j10.90$	$1.59 - j2.68$
2170	$4.80 - j11.75$	$1.62 - j2.70$
2200	$5.55 - j11.87$	$1.54 - j3.13$

Z_{source} = Test circuit impedance as measured from gate to ground.

Z_{load} = Test circuit impedance as measured from drain to ground.

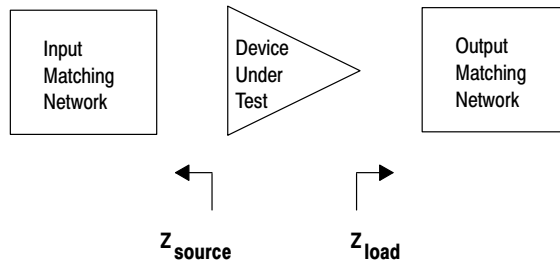

Figure 12. Series Equivalent Source and Load Impedance

NOTES



NOTES

NOTES

PACKAGE DIMENSIONS

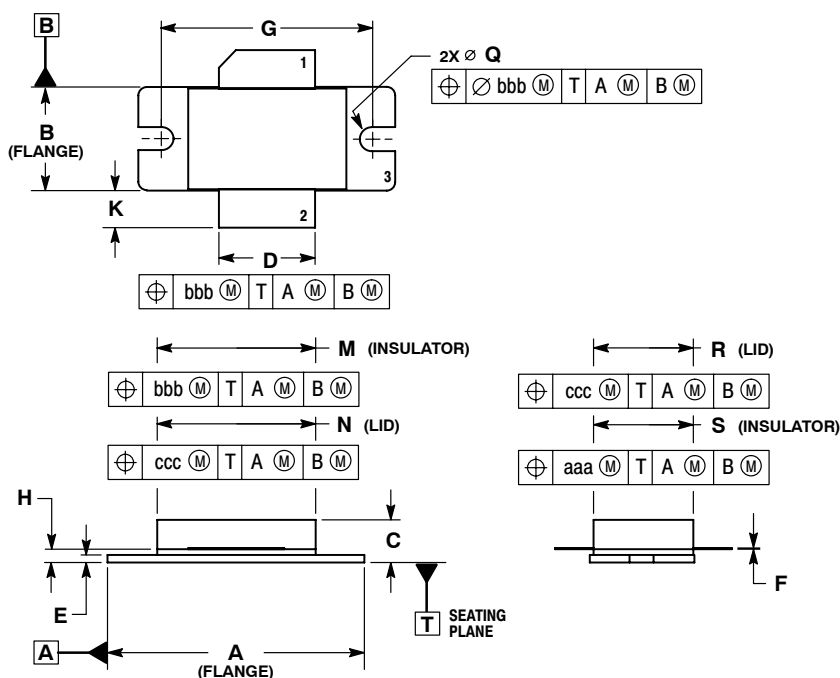

- NOTES:
1. DIMENSIONING AND TOLERANCING PER ANSI Y14.5M-1994.
 2. CONTROLLING DIMENSION: INCH.
 3. DIMENSION H IS MEASURED 0.030 (0.762) AWAY FROM PACKAGE BODY.
 4. DELETED

DIM	INCHES		MILLIMETERS	
	MIN	MAX	MIN	MAX
A	1.335	1.345	33.91	34.16
B	0.535	0.545	13.6	13.8
C	0.147	0.200	3.73	5.08
D	0.495	0.505	12.57	12.83
E	0.035	0.045	0.89	1.14
F	0.003	0.006	0.08	0.15
G	1.100 BSC		27.94 BSC	
H	0.057	0.067	1.45	1.70
K	0.170	0.210	4.32	5.33
M	0.872	0.888	22.15	22.55
N	0.871	0.889	19.30	22.60
Q	∅.118	∅.138	∅3.00	∅3.51
R	0.515	0.525	13.10	13.30
S	0.515	0.525	13.10	13.30
aaa	0.007 REF		0.178 REF	
bbb	0.010 REF		0.254 REF	
ccc	0.015 REF		0.381 REF	

- STYLE 1:
 PIN 1. DRAIN
 2. GATE
 3. SOURCE

**CASE 465B-03
 ISSUE D
 NI-880
 MRF5S21130HR3**

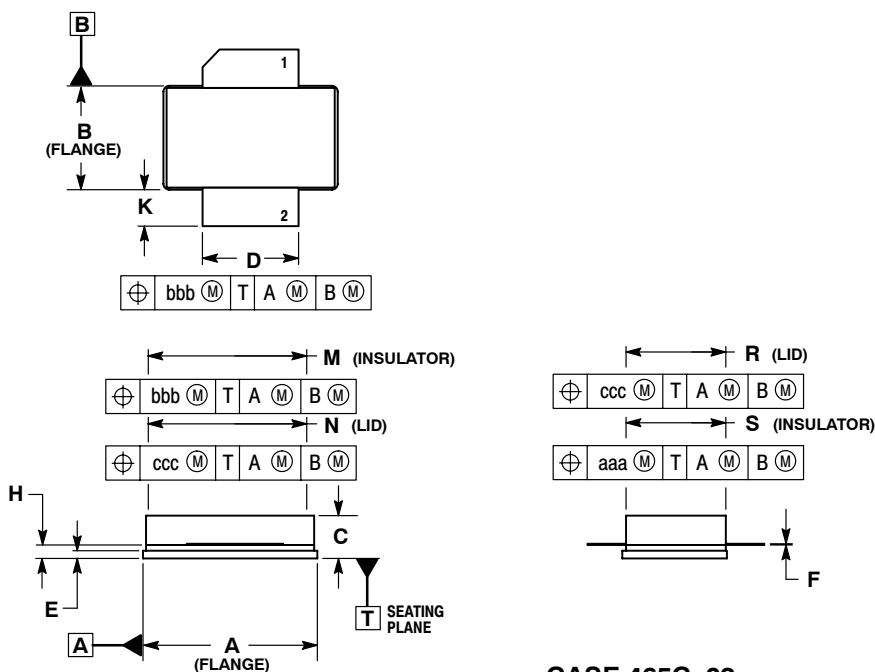

- NOTES:
1. DIMENSIONING AND TOLERANCING PER ANSI Y14.5M-1994.
 2. CONTROLLING DIMENSION: INCH.
 3. DIMENSION H IS MEASURED 0.030 (0.762) AWAY FROM PACKAGE BODY.

DIM	INCHES		MILLIMETERS	
	MIN	MAX	MIN	MAX
A	0.905	0.915	22.99	23.24
B	0.535	0.545	13.60	13.80
C	0.147	0.200	3.73	5.08
D	0.495	0.505	12.57	12.83
E	0.035	0.045	0.89	1.14
F	0.003	0.006	0.08	0.15
H	0.057	0.067	1.45	1.70
K	0.170	0.210	4.32	5.33
M	0.872	0.888	22.15	22.55
N	0.871	0.889	19.30	22.60
R	0.515	0.525	13.10	13.30
S	0.515	0.525	13.10	13.30
aaa	0.007 REF		0.178 REF	
bbb	0.010 REF		0.254 REF	
ccc	0.015 REF		0.381 REF	

- STYLE 1:
 PIN 1. DRAIN
 2. GATE
 3. SOURCE

**CASE 465C-02
 ISSUE D
 NI-880S
 MRF5S21130HSR3**

How to Reach Us:

Home Page:

www.freescale.com

E-mail:

support@freescale.com

USA/Europe or Locations Not Listed:

Freescale Semiconductor
Technical Information Center, CH370
1300 N. Alma School Road
Chandler, Arizona 85224
+1-800-521-6274 or +1-480-768-2130
support@freescale.com

Europe, Middle East, and Africa:

Freescale Halbleiter Deutschland GmbH
Technical Information Center
Schatzbogen 7
81829 Muenchen, Germany
+44 1296 380 456 (English)
+46 8 52200080 (English)
+49 89 92103 559 (German)
+33 1 69 35 48 48 (French)
support@freescale.com

Japan:

Freescale Semiconductor Japan Ltd.
Headquarters
ARCO Tower 15F
1-8-1, Shimo-Meguro, Meguro-ku,
Tokyo 153-0064
Japan
0120 191014 or +81 3 5437 9125
support.japan@freescale.com

Asia/Pacific:

Freescale Semiconductor Hong Kong Ltd.
Technical Information Center
2 Dai King Street
Tai Po Industrial Estate
Tai Po, N.T., Hong Kong
+800 2666 8080
support.asia@freescale.com

For Literature Requests Only:

Freescale Semiconductor Literature Distribution Center
P.O. Box 5405
Denver, Colorado 80217
1-800-441-2447 or 303-675-2140
Fax: 303-675-2150
LDCForFreescaleSemiconductor@hibbertgroup.com

Information in this document is provided solely to enable system and software implementers to use Freescale Semiconductor products. There are no express or implied copyright licenses granted hereunder to design or fabricate any integrated circuits or integrated circuits based on the information in this document.

Freescale Semiconductor reserves the right to make changes without further notice to any products herein. Freescale Semiconductor makes no warranty, representation or guarantee regarding the suitability of its products for any particular purpose, nor does Freescale Semiconductor assume any liability arising out of the application or use of any product or circuit, and specifically disclaims any and all liability, including without limitation consequential or incidental damages. "Typical" parameters that may be provided in Freescale Semiconductor data sheets and/or specifications can and do vary in different applications and actual performance may vary over time. All operating parameters, including "Typicals", must be validated for each customer application by customer's technical experts. Freescale Semiconductor does not convey any license under its patent rights nor the rights of others. Freescale Semiconductor products are not designed, intended, or authorized for use as components in systems intended for surgical implant into the body, or other applications intended to support or sustain life, or for any other application in which the failure of the Freescale Semiconductor product could create a situation where personal injury or death may occur. Should Buyer purchase or use Freescale Semiconductor products for any such unintended or unauthorized application, Buyer shall indemnify and hold Freescale Semiconductor and its officers, employees, subsidiaries, affiliates, and distributors harmless against all claims, costs, damages, and expenses, and reasonable attorney fees arising out of, directly or indirectly, any claim of personal injury or death associated with such unintended or unauthorized use, even if such claim alleges that Freescale Semiconductor was negligent regarding the design or manufacture of the part.

Freescale™ and the Freescale logo are trademarks of Freescale Semiconductor, Inc. All other product or service names are the property of their respective owners.
© Freescale Semiconductor, Inc. 2006. All rights reserved.

